

CAC MULTI - Nástěnná jednotka **Standard Plus PM05~15SP, PC09~15SQ**

SJ Chassis

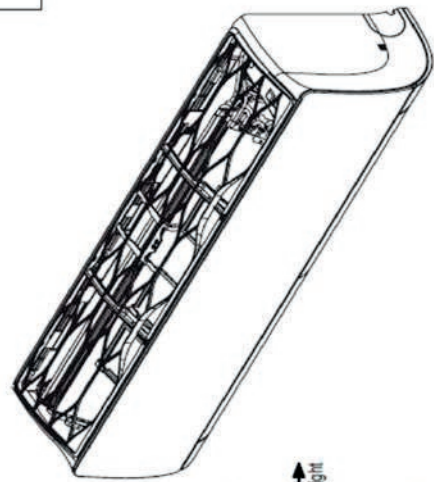

Unit : mm

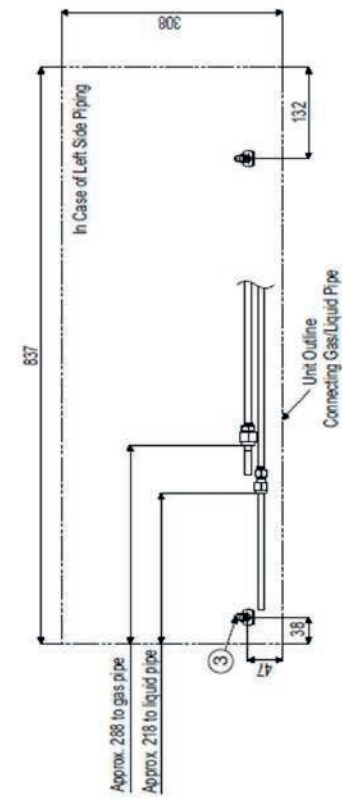
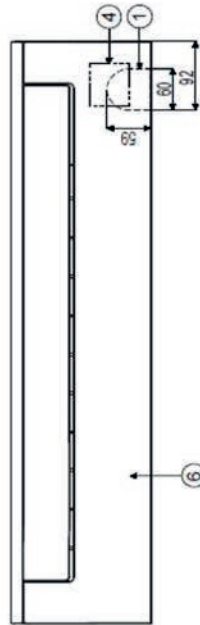
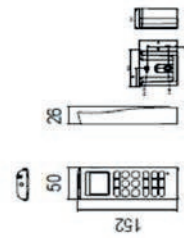
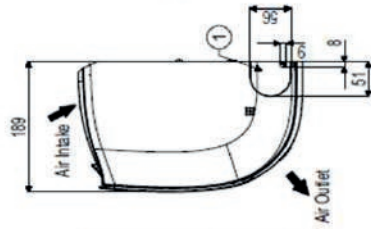
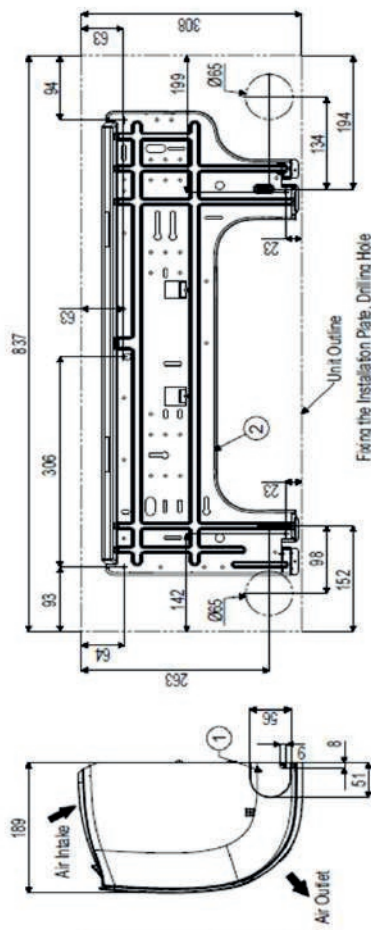
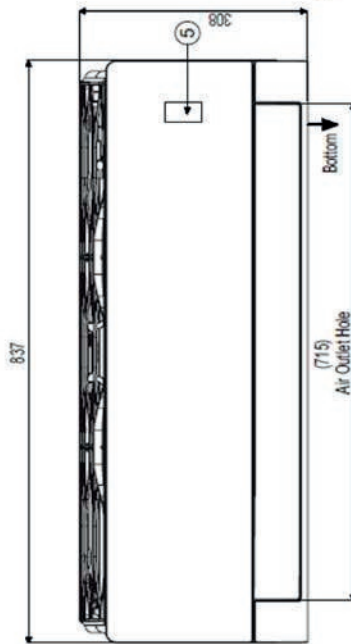
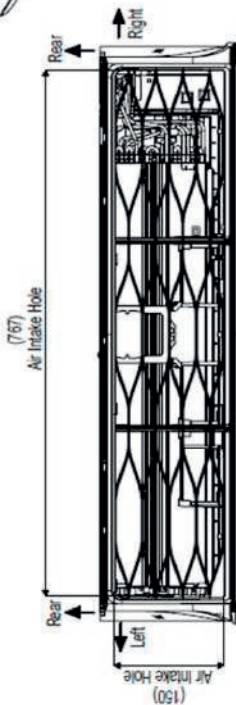

\* If airflow direction control is available,

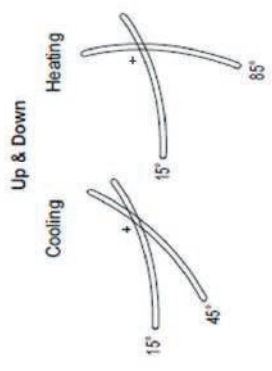

No	Name	Knock-out Type	Description
6	Decoration Cover		
5	Display & Remote Controller Signal Receiver		
4	Terminal Block for Power Supply and Communication		
3	Drain Hose Connection		
2	Installation Plate		
1	Refrigerant, Drain Pipe and Cable Routing Hole		